



OPERATION

- 1) Remove the garden tiller from its trailer/carrier. **Use caution.** 
- 2) Familiarize yourself with the machine and its controls.
- 3) Ensure the safety clutch control lever is in the disengaged position. The safety clutch control lever is located on the left handle bar. The disengaged position of the lever is down.
- 4) Remove the shaft locking pin located behind the wheel axle. Store pin in hole provided on left hand side of handle bar.
- 5) The wheel axle will now pivot. Lift up on the handle to allow wheel axle to pivot. For transport, keep the wheel axle forward. When cultivating, keep the wheel axle rearward for added stability and control. **DO NOT** transport the tiller with the wheel axle in the rear position.
- 6) Adjust depth shoe (if equipped) by removing shaft locking collar and sliding depth shoe to desired position. Replace shaft locking collar.
- 7)  Open fuel shut-off valve. Set choke control to Choke or Start position. Set throttle control to Run or Fast position. Set engine stop switch to On or Run position. Pull starter cord rapidly. Repeat (if necessary) with choke off. 

Typical Throttle & Choke Controls **Stop Switch**
- 8) When in position to begin garden tilling, engage the safety clutch control lever. The tynes will begin rotating. Wheel axle must be in the rear position while tilling. Release the safety clutch control lever to stop the tynes rotating. Tyne speed is governed by engine throttle setting.

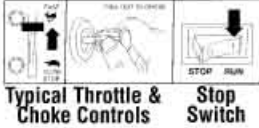

WARNING! – KEEP HANDS AND FEET CLEAR OF TYNES AT ALL TIMES!

- 9) Do not hurry the job. Proceed slowly and allow the machine time to do the job. When ground is extremely hard, reduce engine speed.



WARNING! – IN CASE OF DIFFICULTY, DISENGAGE THE SAFETY CLUTCH CONTROL LEVER. ALL TILLING ACTION STOPS. Press the engine "STOP" button located on the engine.

- 10) **Stop Engine:** Release the safety clutch control lever. Move throttle to Slow position. Set engine stop switch to Stop or Off position. **DO NOT** move choke control to Choke or Start position to stop engine. Backfire or engine damage may occur.

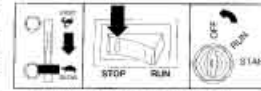

Typical Stop Switches

AFTER USE

- 1)  Turn fuel shut off valve to the "OFF" position.
- 2) Allow machine to cool down.
- 3) Wash mud and dirt off of the garden tiller. Ensure no water enters the carburettor.
- 4) Remove any weeds, wire, rope or other material that may have wrapped around the tynes and rotor assembly.
- 5) Return wheel axle to forward position for transport. Replace shaft locking collar.
- 6) Return depth shoe (if equipped) to full Up position.



SAFETY PRECAUTIONS AND OPERATING INSTRUCTIONS

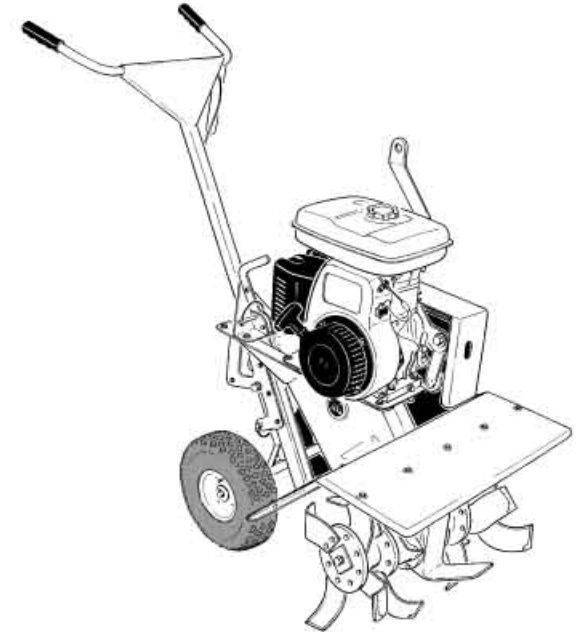



GT5 GARDEN TILLER





 **REDROO.com**
Commercial Outdoor Power Equipment

SAFETY PRECAUTIONS FOR GT5 USERS

USE COMMON SENSE AND PLENTY OF IT

- 1)  **DO NOT** allow any person to operate the garden tiller without first reading and understanding the safety precautions and operating instructions. **KNOW THE CONTROLS AND HOW TO STOP THE GARDEN TILLER QUICKLY IN AN EMERGENCY.**
- 2) **NEVER** allow children to operate the garden tiller.
- 3) **ALWAYS** wear protective clothing when operating the garden tiller. This includes, but is not limited to: safety glasses, loose fitting gloves, steel capped boots and hearing protection. **NEVER** wear loose fitting clothing or jewellery when operating the garden tiller. Keep all clothing away from moving parts. Items could become caught in the machine, resulting in injury.   
- 4) **ALWAYS** operate the garden tiller in a well lit area.
- 5) **ALWAYS** make certain that the safety clutch control lever is in the "disengaged" position prior to starting the engine.
- 6)  **ALWAYS** operate garden tiller on level ground only. Police the area before garden tilling. Remove any foreign objects in the digging area eg bricks, rocks, wire and sticks. Locate and mark any sprinkler heads, water pipes, gas lines, electrical and telephone cables or any other hazard either below or above ground.
- 7)  **DO NOT** allow other persons near the garden tiller. It is up to the operator to keep bystanders and animals a minimum of 6 metres (18ft) away from the machine while in operation.
- 8) **NEVER** operate the garden tiller when fatigued. **ALWAYS BE ALERT!** If you get tired while operating the garden tiller, take a break. If you have any type of physical or

mental condition that may be aggravated by strenuous work, consult with your physician before you operate this equipment. **NEVER** operate the garden tiller under the influence of medication, alcohol or drugs.

- 9)  **ALWAYS KEEP YOUR HANDS, FEET AND BODY AWAY FROM THE DIGGING AREA WHILE ENGINE IS RUNNING.**
- 10)  **NEVER** operate the unit without the safety guards in place and in working order. Keep the unit well maintained and in good working order
- 11) **DO NOT** leave the machine unattended while the engine is running.
- 12) **DO NOT** overspeed the engine or alter the governor settings. Excessive speed is dangerous and will shorten engine life.
- 13)  **NEVER** operate the garden tiller in an enclosed area. Engine exhaust contains carbon monoxide, an odourless and tasteless poison.
- 14)  **STOP** the engine and disconnect the spark plug lead(s) and allow engine to cool before inspecting or performing maintenance on the garden tiller.
- 15)  **REFUELLING**
 - * Shut off engine. **DO NOT REFUEL AN ENGINE WHILE OPERATING!**
 - * Allow engine to cool. Minimum 5 minutes.
 - * **USE UNLEADED FUEL ONLY. Use clean, fresh unleaded fuel.**
 - * **Do not mix oil with unleaded fuel.**
 - * Do not over-fill fuel tank. Allow space for fuel expansion.
 - * Do not smoke.
 - * Allow no naked flame or hot material in refuelling area.
 - * Use only approved fuel containers and funnels. Remember, fuel is a potential hazard.

"STAY ALERT – DON'T GET HURT"

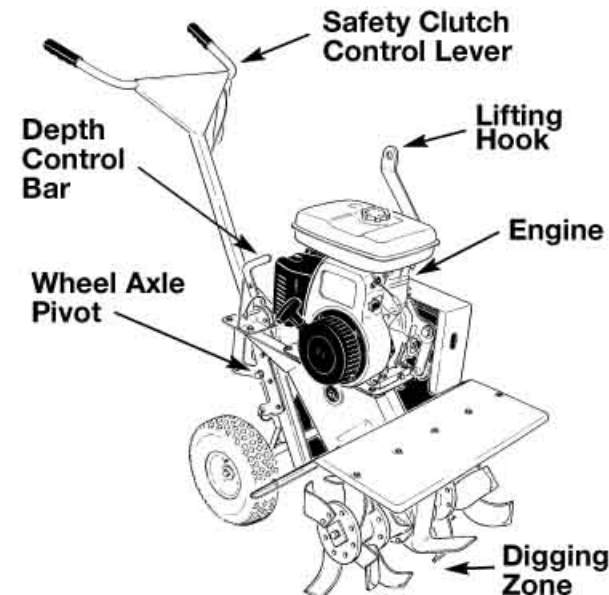

OPERATING INSTRUCTIONS

BEFORE USE

- 1) Ensure that all grass and weeds have been cut as low as possible.
- 2) If the garden tiller is to be used in clay or hard ground conditions, it is recommended to water the area thoroughly and allow sufficient time for the soil to soften.
- 3)  Police the area. Remove any foreign objects from the area.
- 4) Identify and mark the location of sprinkler heads, gas pipes, telephone cables, etc.

safety
IS EVERYBODY'S BUSINESS
...now

You alone know the operational demands and special conditions affecting the equipment in your situation and therefore assume the responsibility for developing, carrying out, and enforcing the safety concepts which apply to your own operation to effect the greatest safety for yourself and the people around you.