







OPERATION



- 1) Familiarize yourself with the log splitter and its controls.
- 2) Wear safety glasses, or helmet and visor combination, loose fitting gloves, and hearing protection. 
- 3) **ALWAYS** make certain that all control levers are in the disengaged position prior to starting the engine.
- 4) Disconnect the hydraulic ram extension from the lifting table and attach the hydraulic ram directly to the lifting table.
- 5)  **DO NOT** allow bystanders near the log splitter while in operation. It is up to the operator to keep bystanders and animals a minimum of 6 metres away from the log splitter while in operation.
- 6)  Open fuel shut-off valve, if engine is equipped. Move choke control to CHOKE or START position. Note: Choke must fully close. Move throttle control to RUN or FAST position. If engine is equipped with rocker style stop switch, push RUN or I (I = Ignition) before starting. Rewind Starter: Grasp rope handle and pull slowly until resistance is felt to prevent kickback. Then pull cord rapidly to overcome compression and start engine. Repeat if necessary with choke off and throttle control in FAST position. Operate engine in FAST position.
- 7) Place wood onto the lifting table. (Do not exceed 250 kgs/550lbs.)
- 8) Lift the wood and roll the wood between the head stock and the splitting head.
- 9)  **NEVER** have your hands between the ram and the log, between the log and the wedge, or between two logs. **NEVER** position log by placing your hand(s) on the end(s) of the log. **ALWAYS** position a log by placing your hand(s) on the side(s) of the log.

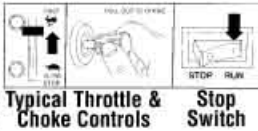

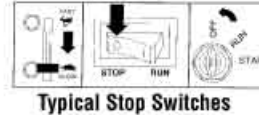
- 10) When splitting wood always operate the logsplitter in front of the axle on the valve side of the beam only.
- 11) Bring the splitting head up to the log and “FEEL” the splitting head into the log. Do not try to force the split, back off and move around the log. Remove hands from log once held by splitting head then proceed to split.
- 12) Split wood in the direction of the grain **only**. Logs to be split should be cut as squarely as possible.
- 13) Never attempt to load the splitter while the ram is in motion.
- 14)  **NEVER** straddle or climb over the splitter while in use.
- 15)  **NEVER** insert hands or fingers into the cracks of the log during the splitting procedure.
- 16) **Stop Engine:** Do not move choke control to CHOKE position to stop engine. Backfire or engine damage may occur. Move throttle control to SLOW position, then push rocker switch to 0 (STOP), or turn key to OFF, if equipped.



AFTER USE

- 1)  Turn fuel tap to “OFF” position.
- 2)  Allow machine to cool down.
- 3)  Clean with warm soapy water. Ensure no water enters the carburettor.



SAFETY PRECAUTIONS AND OPERATING INSTRUCTIONS

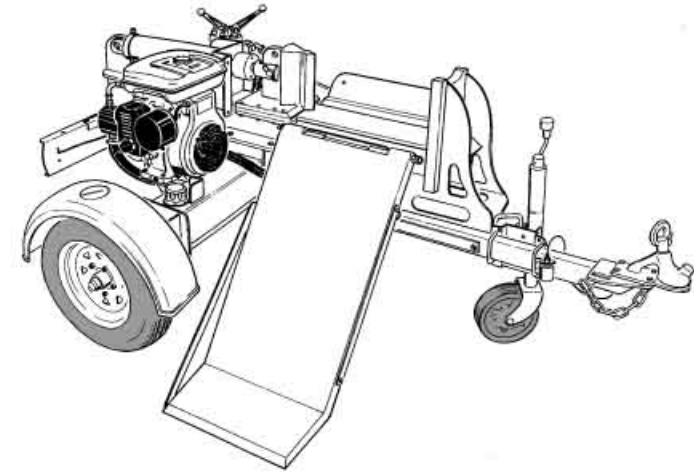

HLS HYDRAULIC LOG SPLITTER



 **REDROO.com**
Commercial Outdoor Power Equipment

SAFETY PRECAUTIONS FOR HLS USERS



USE COMMON SENSE AND PLENTY OF IT

- 1)  **DO NOT** allow any person to operate the log splitter without first reading and understanding this manual. Also read and understand the engine manual. **Know the controls and how to stop the machine quickly in an emergency.**
- 2) **NEVER** allow children or untrained adults to operate the log splitter.
- 3) **ALWAYS** wear protective clothing when operating the log splitter. This includes, but is not limited to; safety glasses, loose fitting gloves, steel capped boots and hearing protection. **NEVER** wear loose fitting clothing or jewellery when operating the log splitter. Keep all clothing away from moving parts. Items could become caught in the machine, resulting in injury.   
- 4) **ALWAYS** operate the log splitter in a well lighted area.
- 5) **NEVER** operate the log splitter on slippery, wet, muddy, or icy surfaces. **ALWAYS** keep your work area clear and free of debris.
- 6)  **DO NOT** allow bystanders near the log splitter while in operation. It is up to the operator to keep bystanders and animals a minimum of 6 metres away from the log splitter while in operation.
- 7) **NEVER** operate the log splitter when fatigued. **ALWAYS BE ALERT!** If you get tired while operating the log splitter, take a break. If you have any type of physical or mental condition that may be aggravated by strenuous work, check with your physician before you operate this equipment. **NEVER** operate the log splitter under the influence of medication, alcohol or drugs.
- 8)  **NEVER** step over the log splitter when it is running – walk around the log splitter to get to the other side.

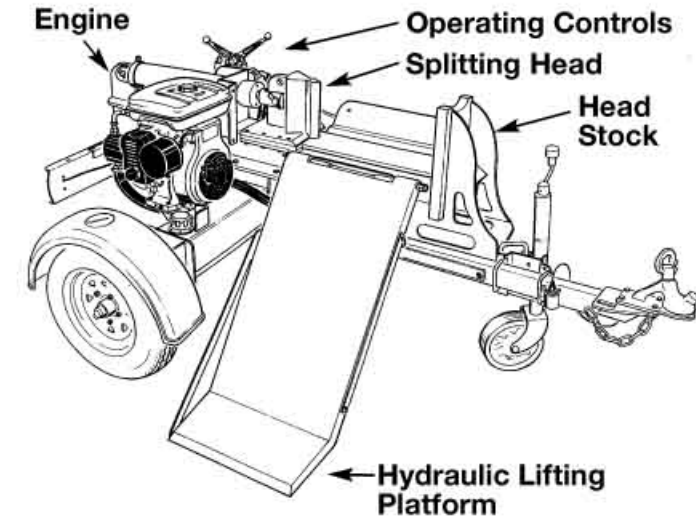

- 9)  **NEVER** have your hands between the ram and the log, between the log and the wedge, or between two logs. **NEVER** position log by placing your hand(s) on the end(s) of the log. **ALWAYS** position a log by placing your hand(s) on the side(s) of the log.
- 10) **DO NOT** overspeed the engine or alter the governor settings. Excessive speed is dangerous and will shorten engine life.
- 11)  **NEVER** operate the log splitter in an enclosed area. Engine exhaust contains carbon monoxide, an odourless and tasteless poison.
- 12) **DO NOT** leave the machine unattended while the engine is running.
- 13)  **STOP** the engine immediately if a hydraulic leak occurs. **DO NOT** operate unit with frayed, kinked, cracked or damaged hose, fittings or tubing.
- 14)  **STOP** the engine and disconnect the spark plug lead(s) and allow engine to cool before inspecting or performing maintenance on the log splitter.
- 15)  **REFUELLING**
 - * Shut off engine. **DO NOT REFUEL AN ENGINE WHILE OPERATING!**
 - * Allow engine to cool. Minimum 5 minutes.
 - * **USE UNLEADED FUEL ONLY.** Use clean, fresh unleaded fuel.
 - * **Do not mix oil with unleaded fuel.**
 - * Do not over-fill fuel tank. Allow space for fuel expansion.
 - * Allow no naked flame or hot material in refuelling area.
 - * Do not smoke.
 - * Use only approved fuel containers and funnels. Remember, fuel is a potential hazard.
 - * Refer to engine owners manual for full details.

“STAY ALERT – DON’T GET HURT”



OPERATING INSTRUCTIONS

TRANSPORT

- 1)  **WARNING** make sure the Hydraulic Lifting Platform is in the highest possible position (inside the mudguard) before towing. Make sure that the hydraulic ram has the ram extension in place to lift the platform to the highest possible position.
- 2) **DO NOT** exceed 60kms per hour (45mph) when towing this product.  

BEFORE USE

- 1) Perform a thorough visual inspection of the log splitter.
- 2) **ALWAYS** keep your work area clear and free of debris.